

3 años
GARANTÍA
INTERNACIONAL

 **Exceline**
Excelencia en protección



Cualquiera sea su aire acondicionado, **Exceline**
tiene **LA MÁS AMPLIA Y CONFIABLE**
gama de protectores de voltaje

El principal elemento a cuidar en la unidad de Aire Acondicionado es **EL COMPRESOR**



¡Hay **fallas eléctricas** que pueden causar daños permanentes en el compresor!

¿Qué fallas eléctricas pueden dañar su Aire Acondicionado?



➤ *Voltaje bajo*

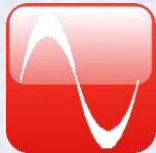

➤ *Voltaje alto*



➤ *Apagones de corta duración*

➤ *Voltaje Bajo / Alto*



Provocan calentamiento excesivo en el compresor. Esto no sólo daña el motor, sino también el lubricante y las partes mecánicas.

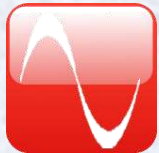

➤ *Apagones de Corta Duración*



Obligan al compresor a arrancar sin que se hayan balanceado las presiones del sistema. Esto deteriora en el compresor y causa su falla prematura.

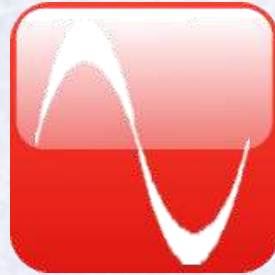

Los protectores para Aires Acondicionados **EXCELINE** protegen a su equipo contra Voltaje Alto, Voltaje Bajo y Apagones de Corta Duración.



Conozca la **AMPLIA GAMA** de protectores
Exceline para Aire Acondicionado



GSM-RE



GSM-RB



GSM-RT



GST-R



GSM-N



GSM-N 120 V

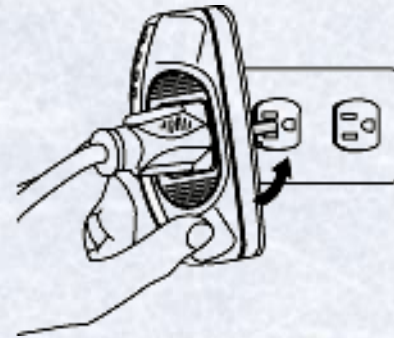

Entrada y Salida Enchufable



**Aires Acondicionados
de Ventana**

Hasta 5.000 BTU



GST-RE 120 V

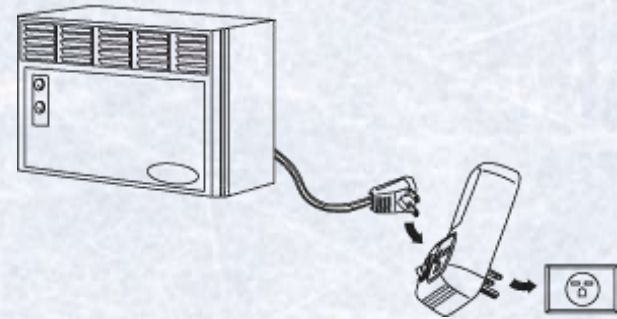

Entrada y Salida Enchufable



**Aires Acondicionados
de Ventana, Portátil y Split**

Hasta 12.000 BTU



GST-RE 220M

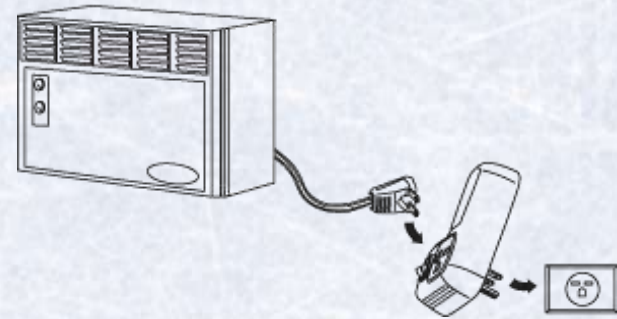

Entrada y Salida Enchufable



Aires Acondicionados
de Ventana, Portátil y Split
Hasta 27.000 BTU



GST-RE 220C

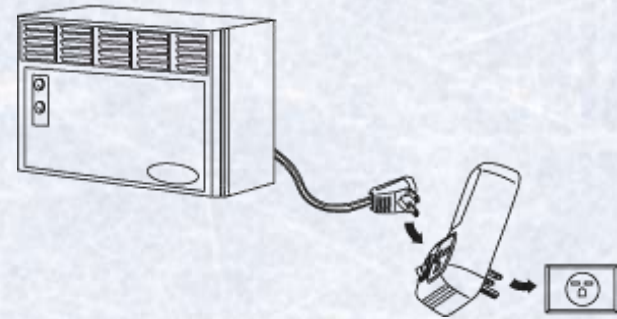

Entrada y Salida Enchufable



**Aires Acondicionados
de Ventana, Portátil y Split**

Hasta 27.000 BTU



GST-RT 120 V



**Entrada Cableada y
Salida Enchufable**



**Aires Acondicionados
de Ventana, Portátil y Split
Hasta 12.000 BTU**



GST-RT 220 V



**Entrada Cableada y
Salida Enchufable**



**Aires Acondicionados
de Ventana, Portátil y Split
Hasta 27.000 BTU**



GSM-R 120B

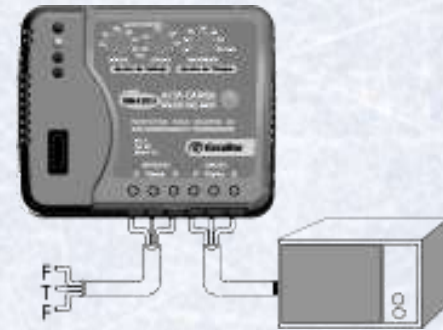

Entrada y Salida Cableada

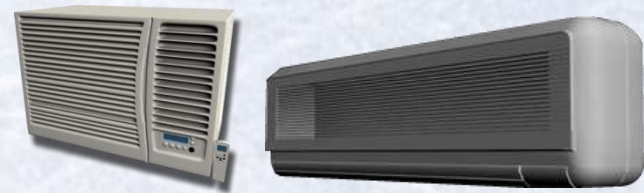

**Aires Acondicionados
de Ventana y Split**

Hasta 18.000 BTU



GST-R 220B

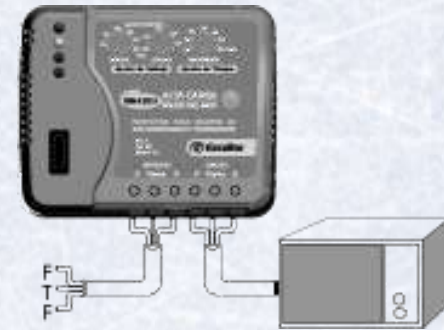

Entrada y Salida Cableada



**Aires Acondicionados
de Ventana, Portátil, Split y Piso Techo**

*** Puede manejar mayor capacidad a través de contactor**

Hasta 36.000 BTU*

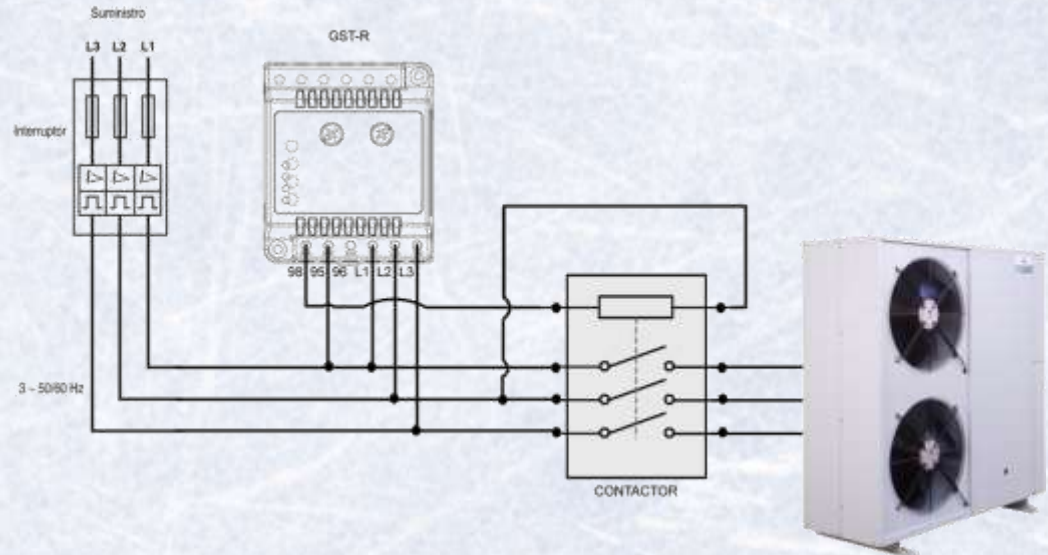

GST-R 220/208 V

Manejo a través de Contactor

Para A/A Trifásico

Sea cual sea su aplicación...
... *Exceline* ofrece la mejor protección

